



# Original Instructions

littleTOWN

GARDEN  
FAIR

## NEST SWING

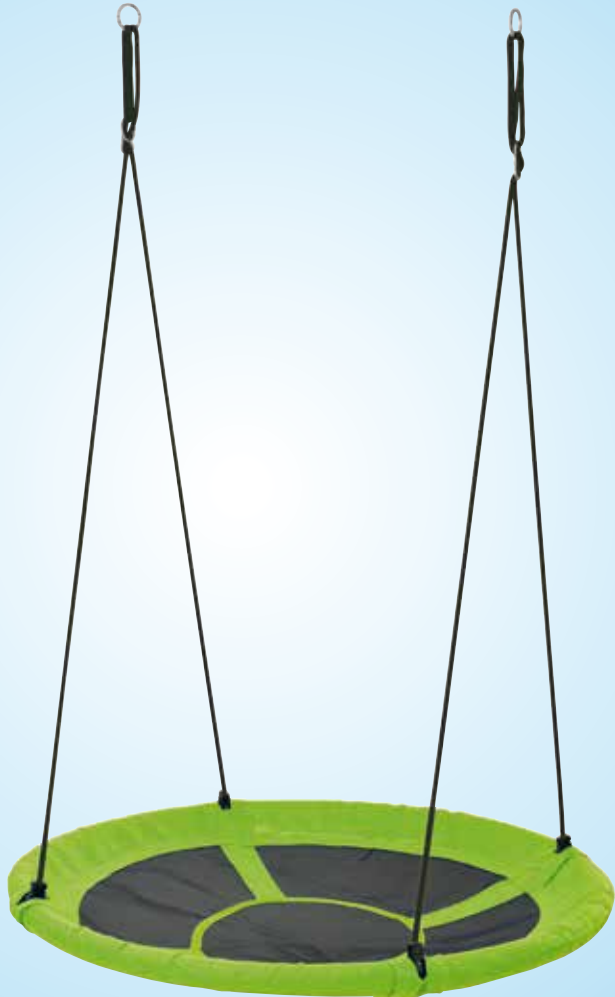

# Table of Contents

<b>Scope of delivery/parts</b> .....	<b>3</b>
Assembly of the nest swing .....	4
Assembly/disassembly of the nest swing .....	5
<b>General</b> .....	<b>6</b>
Read the operating instructions, and keep them ready for use .....	6
Explanation of symbols .....	6
<b>Safety</b> .....	<b>7</b>
Intended use.....	7
Safety information .....	7
Attachment.....	8
Height adjustment.....	9
<b>Maintenance of the swing</b> .....	<b>10</b>
Disposal.....	10
Declaration of Conformity .....	10
<b>Warranty card (separately in the booklet)</b>	

## Scope of delivery / device parts

- 1 Sitting surface of the nest swing
- 2 4 frame tubes with padding
- 3 2 ropes with plastic supports

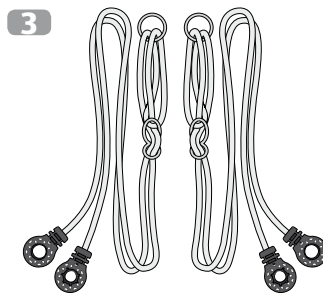
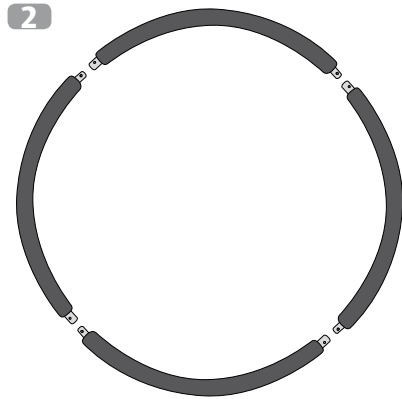
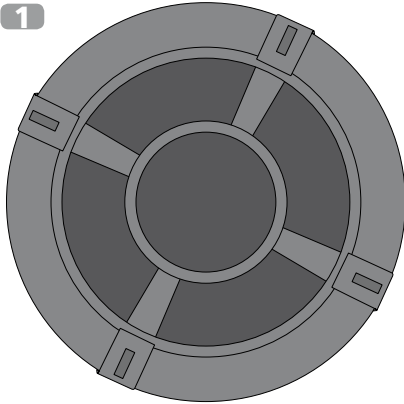

### Risk of injury!

Improper handling of the nest swing may cause serious injury.

### Assembly steps

Assemble the nest swing by using the following instructions and drawings.

Carry out all assembly steps completely in the specified sequence.

Familiarise yourself with the individual parts shown before starting the assembly.

## Assembly:

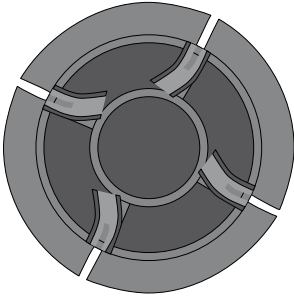

1. Lay the seat surface on the floor and open the tabs with the Velcro straps.

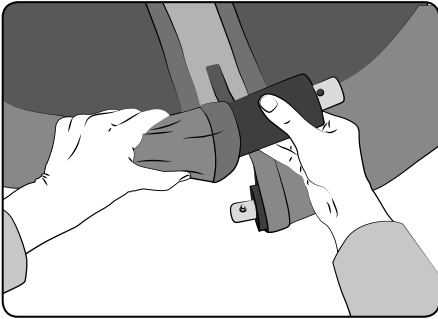

2. Push the 4 frame tubes with the padding into the pockets provided on the seat one after the other.

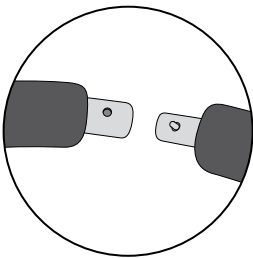

3. Make sure that a thicker tube end with a hole follows a pipe end with a spring button.

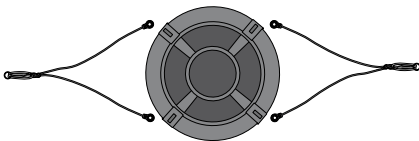

4. Place the two ropes with the suspensions made of plastic in the correct sequence next to the nest swing. Please make sure that the ropes are not twisted.

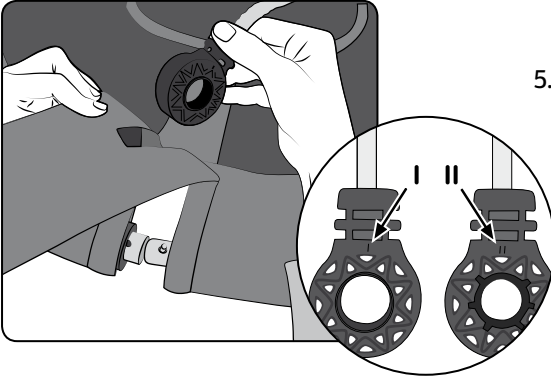

5. Slide the plastic suspension of the rope from above through the opening of the tab with the Velcro straps. Then use side II (see marking) to attach the suspension to the thicker tube.

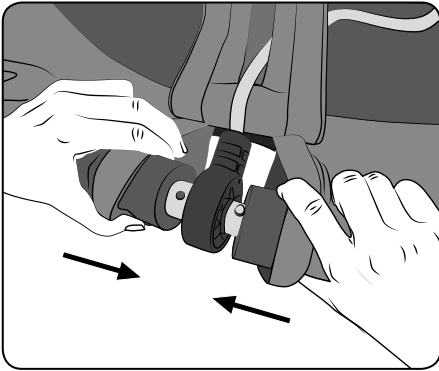

6. Now connect the tubes to each other, while pressing down the spring pressure button on the thinner end of the tube. The interlocking is achieved through the latching and clicking of the push button.
7. Now, close the tab with the Velcro straps. The assembly is now completed.

## Disassembly:



Open the Velcro strap and push the padding aside. Release the spring pressure button to subsequently pull the frame tubes apart.

## General

### Read the operating instructions and store them



This instruction manual is part of the nest swing. It contains important information on the initial set up and handling.

Carefully read the operating instructions, especially the safety instructions, before using the nest swing. Failure to follow these operating instructions may result in serious injury or damage to the nest swing. The operating instructions are based on the standards and regulations which are valid within the European Union. Observe country-specific guidelines and laws which are applicable abroad. Store the operating instructions adequately to enable future use. If you pass on the nest swing to a third party, be sure to include these operating instructions.

### Explanation of symbols

The following symbols and signal words are used in these operating instructions, on the nest swing or on the packaging.



This signal symbol/word indicates a hazard with a medium risk level which, if not avoided, may result in death or injury.



This signal word warns of possible damage to property.



This symbol gives you useful additional information for the use of the nest swing.



Declaration of conformity (Chapter "Declaration of Conformity"): Products marked with this symbol comply with all applicable Community Regulations of the European Economic Area.



**WARNING!**  
Not suitable for children under 3 years due to small parts choking hazard and risk of strangulation due to long cords.



The TÜV Rheinland certificate "Safe Toy" serves as proof of an independently tested, precisely defined and constant quality. It confirms the safety (checking for harmful substances) and suitability for use (e.g. functional properties, wear behaviour, service life) of a product and thus its comprehensive quality.

## Safety

### Intended use

**⚠ WARNING!**

**WARNING!** Maximum load: 150 kg.

**WARNING!** Suitable for children aged 3 and over.

**WARNING!** Intended for outdoor use.

**WARNING!** Only suitable for home use.

For domestic use only. 2 adults are required for the assembly. Only use the nest swing as described in these operating instructions. Any other use is considered to be improper use and may result in damage to property or even personal injury. The manufacturer or dealer accepts no liability for damage caused by improper or incorrect use.

### Safety information

**⚠ WARNING!**

**WARNING! Not suitable for children under 3 years due to small parts choking hazard and risk of strangulation due to long cords.**

Remove all packaging before giving the toy to a child.

- Do not let children play with the packaging film.
- Keep children away from small parts.

**⚠ CAUTION!**

The item contains small parts: Risk of suffocation!

The maximum load may not exceed 150 kg!

The assembly may only be carried out by adults! Only 1 person may swing at a time!

**⚠ NOTE!**

Suitable for children over 3 years of age. Do not leave children unattended during use. Take precautions.

### Safety guidelines

The free space around the swing should ideally be 4 meters.

Activity toys may not be built over concrete, asphalt or other hard surfaces. Falling on hard ground often causes serious injuries. Do not use the swing until it has been completely installed. The swing may not be used for purposes other than those intended. Supervision by adults is required. Adults must check the functionality of the ropes before use. Children must wear appropriate clothing (no ponchos, scarves or other loose hanging garments). Swinging is only allowed if the swinging person sits in the middle of the seat. Avoid swinging with an empty seat, as this can pose a risk of strangulation.

## Safety guidelines

If you make any changes to your nest swing, it must be approved by the manufacturer and carried out in accordance with the manufacturer's instructions.

**Caution:** Only original parts may be used; these are available from the manufacturer. Installations must be completed in accordance with the instruction manual.

### Supervisors must instruct children as follows:

- Never walk towards the swing, behind the swing or between two swings whilst they are in use.
- Do not turn the ropes or hang them over the tubes as this will impair the strength of the ropes.
- Do not jump off the swing while swinging.
- Do not climb on a wet swing.
- Do not attach any additional elements to the swing.



Helmets and loose or wide clothing may cause personal injury.

There is a risk of falling and strangulation. There is a serious risk of injury if the nest swing is broken or torn off during use. Be sure to only create absolutely safe constructions during the installation.



### Attachment hooks

Serious risk of injury by tearing off of the nest swing during use. Only mount the nest swing on a suitable mounting bracket. If necessary, receive a consultation from people with the relevant expertise. Do not install the nest swing over concrete, asphalt or other hard surfaces.

### There are two possible mounting options:

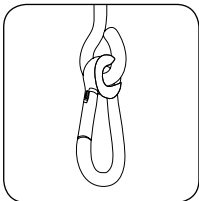

Version 1:

A fully closed support eyelet: Here, the rings of the swing are fastened with a snap hook.

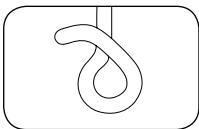

Version 2:

A swing hook: Here, the rings of the nest swing are hung into the support.

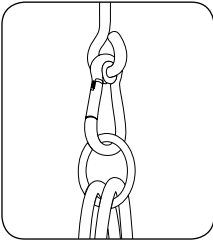

**⚠ NOTE!**

The eyelet of the support must be placed transversely to the swinging direction. This prevents excess wear when swinging.

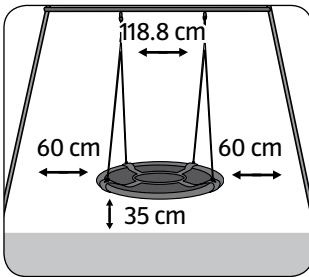
**⚠ NOTE!**

The suspension points must be spaced at least a swing seat width (+10 cm) apart from each other.

The distance between the swing seat and the floor must be at least 35 cm; the maximum height of fall may not exceed 46 cm. Adjust the swing in such a way that the swinging person cannot touch the ground with the tips of their toes. In case of doubt, carry out some light test swings.

The lateral distance must be 60 cm.

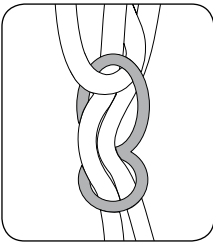
**Height adjustment**

The height of the nest swing can be adjusted through the openings in the adjustment element. This allows the length of the ropes to be changed accordingly. When adjusting the rope length, nobody should be sitting on the swing. Make sure that the ropes are always the same length.

It is imperative that you inspect the ropes regularly for damage or signs of age-related wear and tear, as only an intact rope can guarantee full safety. Be sure to replace damaged ropes.

**⚠ NOTE!**

Please observe that the material can heat up when exposed to intense sunlight, the orientation should therefore preferably be towards north.



## Maintenance of the swing

Before each use of the swing, the supervisor should carry out the following tasks and repeat them at least once a month:

Clamp the tubes, check the swing seats, chains, ropes and other accessories for signs of wear and tear; defective parts must be replaced in accordance with the manufacturer's instructions.

Check all protective devices for completeness and damage. Check all moving parts, and replace them if necessary. Check metal parts for rust, only apply lead-free paint acc. to EN 71 requirements. If this swing is mounted on a frame with several swing elements, absolutely check all the parts. If the swing is hung on a branch, please check it for the proper load bearing characteristics. Check the substrate to see whether it is able to provide a cushioning in case of a fall. At the end of the gardening season, at the latest at temperatures below 4 °C, remove the swing and store it in a dry and frost-free place. Only use original spare parts from Flexxtrade GmbH & Co. KG, since other ropes, tubes, and seating surfaces do not fit on the nest swing, and could therefore entail safety hazards.

## Technical data:

Model: FLX-NS-02NS, Ø 110 cm, max. load capacity 150 kg

## Disposal



### Disposal of packaging

Dispose of the packaging sorted by type. Dispose of cardboard and other related substances in the waste paper collection, and foils in the recyclable waste collection.

## Declaration of Conformity:

The manufacturer Flexxtrade GmbH & Co. KG hereby declares that the nest swing complies with the relevant Community harmonisation legislation:

Directive 2009/48/EC on the Safety of Toys

Applied harmonised standards or specifications /

EN 71-1: 2014+A1, EN 71-2: 2011+A1, EN 71-3: 2013+A3, EN 71-8: 2018





Great care has gone into the manufacture of this product and it should therefore provide you with years of good service when used properly. In the event of product failure within its intended use over the course of the first 3 years after date of purchase, we will remedy the problem as quickly as possible once it has been brought to our attention. In the unlikely event of such an occurrence, or if you require any information about the product, please contact us via our helpline support services, details of which are to be found both in this manual and on the product itself.



**PRODUCED IN CHINA FOR:**

ALDI STORES LTD. PO BOX 26, ATHERSTONE  
WARWICKSHIRE, CV92SH.

ALDI STORES (IRELAND) LTD.  
PO BOX 726, NAAS, CO. KILDARE.  
Visit us at [www.aldi.com](http://www.aldi.com)

**AFTER SALES SUPPORT**

83361



00800/78747874



00800/78747874



[flexxtrade-gb@teknihall.com](mailto:flexxtrade-gb@teknihall.com)

[flexxtrade-ie@teknihall.com](mailto:flexxtrade-ie@teknihall.com)

MODEL:

FLX-NS-02NS

05 / 2021

**3**  
YEAR  
WARRANTY